

PRESYS®

Temperature Advanced Calibrators

TA-700PL



Technical Manual

EM0350-01



WARNING!

Avoid electric shock risk on touching the equipment:

- Use only suitable power cable with earth connection;
 - Never power the equipment to the mains socket with no earth connection.
-



WARNING!

High voltage is present inside these equipments. It can cause great damages and injuries.

Do not make any repair service inside the equipment without removing the plug from the supply.



WARNING!

Much electromagnetic noise can cause instability to the equipment.

The equipment is provided with electromagnetic interference filters that protect not only the mains but also the equipment itself against noise. These filters have no function if the unit is not earthed properly.



WARNING!

High temperatures are achieved in these equipments.

Risk of fire and explosion are present in case safety measures are not taken. Sign by means of warnings the hazardous areas at high temperatures.

Do not place the dry-block on inflammable surfaces or even on materials that can be deformed due to high temperatures.

Do not obstruct any air-vent to avoid risk of fire in the equipment.



WARNING!

The instruments described in this technical manual are equipment for use in specialized technical area.

The user is responsible for configuration and selection of values of the parameters of the instruments.

The manufacturer warns against the risk of incidents with injuries to both persons and property, resulting from the incorrect use of the instrument.



WARNING!

Never remove the insert from the dry-block or the thermo-elements from the insert, while they are in temperatures far from the ambient. Wait until they reach the ambient temperature so that the heterogeneous cooling of the parts do not jam each other. If, by chance, it happens a jamming situation, refer to item 6.2 - *Instructions for Insert Jamming* to proceed properly.

Disposal calibrator:



NO HOUSEHOLD WASTE!

The calibrator of the series TA Calibrator consist of various different materials. It must not be disposed of with household waste.

The warranty conditions are available in our sites:

www.presys.com.br/warranty

Table of Contents

1 - Introduction.....	2
1.1 - Technical Specifications.....	3
1.1.1 - Input Technical Specifications	4
1.1.2 - Special Software Features	5
1.2 - Order Code	5
1.3 - Accessories.....	6
1.4 - Parts Identification.....	8
1.5 - Instruction for use of the optional Black Body insert	9
2 - Calibrator Operation.....	11
2.1 - Calibrator Menu.....	12
2.1.1 - Probe Settings	14
2.1.2 - Input Settings.....	16
2.1.3 - Special Function	19
2.1.4 - Saving Current Configuration (Memory Manager).....	20
2.2 - Hart® Configuration	21
2.2.1 - HART® Connections.....	21
2.2.2 - Starting Communication	22
2.2.3 - Adjusting the Measurement Range of a HART® Transmitter.....	22
2.2.4 - Adjusting the Measurement Range of a HART® Transmitter with Reference.....	23
2.2.5 - Checking / Adjusting HART® Transmitter mA Output	24
2.3 - Automatic Tasks.....	25
2.3.1 - Creating Tasks	25
2.3.2 - Performing Tasks	27
2.3.3 - Viewing Results	28
2.4 - Data-Logger	29
2.5 - Videos	31
2.6 - Settings	31
2.6.1 - System.....	31
2.6.2 - Network	32
2.6.3 - Built-in Web Server.....	32
3 - Safety Instructions	34
4 - Recommendations as regards Accuracy of Measurements.....	34
5 - Calibration (Adjustment).....	34
5.1 - Input Calibration	35
5.2 - Probe Calibration	36
5.3 - PID Control Parameters	37
6 - Maintenance	38
6.1 - Instructions for Hardware Maintenance	38
6.2 - Instructions for Insert Jamming	38

1 - Introduction



TA-700PL

The **TA-700PL** Advanced Temperature Calibrator has a large volume of calibration and design aimed to minimize axial, radial gradients, charge effect and provide extremely high thermal stability in its operating range.

Temperature Advanced Calibrator **TA-700PL** generates temperature in the insert in order to calibrate thermocouples, RTDs, glass thermometers, thermo-switches. Besides providing high accuracy temperature values, it also allows the measurement of signals generated by the thermo-element which is being calibrated. This is possible due to an embedded calibrator specific for these types of signal, including 4-20 mA. Thus, they incorporate the functions of dry block, standard thermometer and calibrator for RTD, TC and mA.

- TA-700PL calibrator model generates temperatures from ambient to 700 °C.
- Present inputs for mA, thermocouples, RTDs and thermo-switches.
- Make no use of external standard thermometer.
- Carry out completely automatic calibrations with or without the use of a computer.
- Accuracy to $0.1^{\circ}\text{C} \pm 0.1\%$ of reading, stability of 0.05°C and resolution of 0.01°C .
- Hart[®] Communicator (optional) with internal resistance configurable, transmitter power supply and latest DD as option.
- Portable, compact, provides interchangeable inserts and carrying case.

They present a wide variety of programming resources, allowing the performance of automatic calibrations. In this case, the sensor is placed in the insert and its electrical terminals are connected to the embedded calibrator. The operator defines the calibration points and the number of repetitions (task), then the process is started and all the sequence is automatically accomplished. After completing the task, a Calibration Report is issued and it can be printed directly in a USB connected printer or can be generated a PDF document.

It has HART[®] communication for reading and setting parameters of field devices that have this protocol.

Another way of performing automatic documented calibrations is by means of Calibration Software for PC/Windows[™], which uses USB communication to connect the computer to the calibrator.

TA-700PL have also many other features, such as:

- RTD input for 2, 3 and 4 wires. Table IEC 60751, JIS or CallendarVan Dusen userconfigurable. Engineering units configurable to °C, °F and K.
- Built in Web Server, Ethernet communication.
- USB port for software/firmware upgrade.
- HART[®] Communication Protocol (optional).
- The electric signal calibrator is independent from the dry block function.
- Display indication when the temperature reaches the desired value.
- 5.7 inches touchscreen display that eases the operation and configuration of the calibrator.
- Thermo-element reading scaled to ITS-90 or IPTS-68.
- Internal regulated 24 Vdc power supply for 2-wire transmitters.
- Independent circuit for over-temperature protection and safety.
- Insert to choose, carrying case, handles and test leads included.

1.1 - Technical Specifications

	TA-700PL
Operating Range	from ambient temperature to 700 °C (1292 °F)
Display Accuracy	± (0.1 °C + 0.1% of reading)
Resolution	0.01 °C or 0.01 °F
Stability	± 0.05 °C
Radial Uniformity (homogeneity)	± 0.05 °C @ 50 °C ± 0.10 °C @ 150 °C ± 0.20 °C @ 660 °C
Axial Uniformity (homogeneity) (40 mm)	± 0.10 °C @ 50 °C ± 0.20 °C @ 150 °C ± 0.40 °C @ 660 °C
Heating Time	30 min (50 °C to 660 °C)
Cooling Time	140 min (660 °C to 100 °C)
Electric Power:	1000 W
Well Diameter x Depth	Ø 36 mm x 155 mm
Weight	10.5 kg
Dimension (HxWxD)	315 x 200 x 305 mm
Environmental Operating Conditions	0 to 50 °C / 0 to 90 % RH

1.1.1 - Input Technical Specifications

	Input Ranges	Resolution	Accuracy	Remarks
	millivolt -150 mV to 150 mV	0.001 mV	± 0.01 % FS*	R _{input} > 10 MΩ auto-ranging
	150 mV to 2450 mV	0.01 mV	± 0.02 % FS	
	mA -1 mA to 24.5 mA	0.0001 mA	± 0.01 % FS	R _{input} < 120 Ω
	resistance 0 to 400 Ω	0.01 Ω	± 0.01 % FS	Excitation current 0.85 mA auto-ranging
	400 to 2500 Ω	0.01 Ω	± 0.03 % FS	
	Pt-100 -200 to 850 °C / -328 to 1562 °F	0.01 °C / 0.01 °F	± 0.1 °C / ± 0.2 °F	IEC 60751
	Pt-1000 -200 to 400 °C / -328 to 752 °F	0.1 °C / 0.1 °F	± 0.1 °C / ± 0.2 °F	IEC 60751
	Cu-10 -200 to 260 °C / -328 to 500 °F	0.1 °C / 0.1 °F	± 2.0 °C / ± 4.0 °F	Minco 16-9
	Ni-100 -60 to 250 °C / -76 to 482 °F	0.1 °C / 0.1 °F	± 0.2 °C / ± 0.4 °F	DIN-43760
	TC-J -210 to 1200 °C / -346 to 2192 °F	0.1 °C / 0.1 °F	± 0.2 °C / ± 0.4 °F	IEC 60584
	TC-K -270 to -150 °C / -454 to -238 °F	0.1 °C / 0.1 °F	± 0.5 °C / ± 1.0 °F	IEC 60584
	TC-K -150 to 1370 °C / -238 to 2498 °F	0.1 °C / 0.1 °F	± 0.2 °C / ± 0.4 °F	IEC 60584
	TC-T -260 to -200 °C / -436 to -328 °F	0.1 °C / 0.1 °F	± 0.6 °C / ± 1.2 °F	IEC 60584
	TC-T -200 to -75 °C / -328 to -103 °F	0.1 °C / 0.1 °F	± 0.4 °C / ± 0.8 °F	IEC 60584
	TC-T -75 to 400 °C / -103 to 752 °F	0.1 °C / 0.1 °F	± 0.2 °C / ± 0.4 °F	IEC 60584
	TC-B 50 to 250 °C / 122 to 482 °F	0.1 °C / 0.1 °F	± 2.5 °C / ± 5.0 °F	IEC 60584
	TC-B 250 to 500 °C / 482 to 932 °F	0.1 °C / 0.1 °F	± 1.5 °C / ± 3.0 °F	IEC 60584
	TC-B 500 to 1200 °C / 932 to 2192 °F	0.1 °C / 0.1 °F	± 1.0 °C / ± 2.0 °F	IEC 60584
	TC-B 1200 to 1820 °C / 2192 to 3308 °F	0.1 °C / 0.1 °F	± 0.7 °C / ± 1.4 °F	IEC 60584
	TC-R -50 to 300 °C / -58 to 572 °F	0.1 °C / 0.1 °F	± 1.0 °C / ± 2.0 °F	IEC 60584
	TC-R 300 to 1760 °C / 572 to 3200 °F	0.1 °C / 0.1 °F	± 0.7 °C / ± 1.4 °F	IEC 60584
	TC-S -50 to 300 °C / -58 to 572 °F	0.1 °C / 0.1 °F	± 1.0 °C / ± 2.0 °F	IEC 60584
	TC-S 300 to 1760 °C / 572 to 3200 °F	0.1 °C / 0.1 °F	± 0.7 °C / ± 1.4 °F	IEC 60584
	TC-E -270 to -150 °C / -454 to -238 °F	0.1 °C / 0.1 °F	± 0.3 °C / ± 0.6 °F	IEC 60584
	TC-E -150 to 1000 °C / -238 to 1832 °F	0.1 °C / 0.1 °F	± 0.1 °C / ± 0.2 °F	IEC 60584
	TC-N -260 to -200 °C / -436 to -328 °F	0.1 °C / 0.1 °F	± 1.0 °C / ± 2.0 °F	IEC 60584
	TC-N -200 to -20 °C / -328 to -4 °F	0.1 °C / 0.1 °F	± 0.4 °C / ± 0.8 °F	IEC 60584
	TC-N -20 to 1300 °C / -4 to 2372 °F	0.1 °C / 0.1 °F	± 0.2 °C / ± 0.4 °F	IEC 60584
	TC-L -200 to 900 °C / -328 to 1652 °F	0.1 °C / 0.1 °F	± 0.2 °C / ± 0.4 °F	DIN-43710
	TC-C 0 to 1500 °C / 32 to 2732 °F	0.1 °C / 0.1 °F	± 0.5 °C / ± 1.0 °F	W5Re / W26Re
	TC-C 1500 to 2320 °C / 2732 to 4208 °F	0.1 °C / 0.1 °F	± 0.7 °C / ± 1.4 °F	W5Re / W 26Re

Accuracy values are valid within one year and temperature range of 20 to 26 °C. Outside these limits add 0.001 % FS / °C taking 23 °C as the reference temperature. For thermocouples, using the internal cold junction compensation add a cold junction compensation error of ± 0.2 °C or ± 0.4 °F max.

1.1.2 - Special Software Features

- **Special Function:**
SCALE: makes the scaling of mA input.
- **Memory Manager:** stores configuration types predefined by the user.
- **Automated Tasks:** creating of calibration work orders and automatic execution of calibration services, storage of data and reporting.
- **Data Logger:** monitoring of input or output signals, storage and visualization of data in chart or table.
- **Videos:** storage and viewing videos on the calibrator screen.

1.2 - Order Code

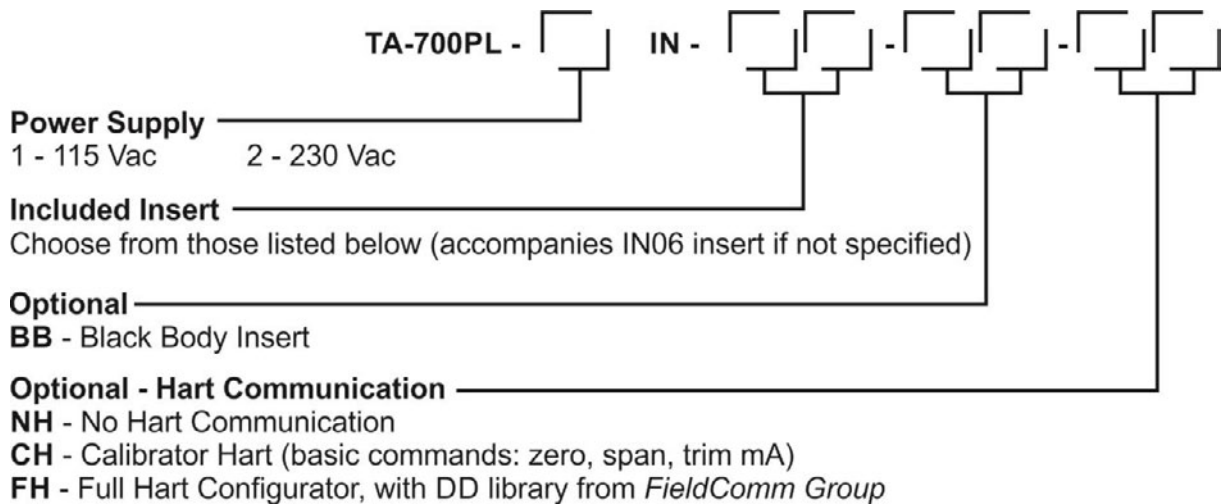

1.3 - Accessories

Inserts	Holes	Order Code
IN01	1 x 3/4"	06.04.0062-00
IN02	1 x 1/2"	06.04.0063-00
IN03	1 x 6.0mm and 3 x 1/4"	06.04.0064-00
IN04	3 x 6.0mm and 1 x 1/4"	06.04.0065-00
IN05	4 x 6.0mm	06.04.0066-00
IN06	2 x 6.0mm and 2 x 1/4"	06.04.0067-00
IN07	1 x 6.0mm, 1 x 8.0mm and 1 x 3/8"	06.04.0068-00
IN08	1 x 6.0mm, 1 x 3.0mm and 2 x 1/4"	06.04.0069-00
IN09	Without hole, to be drilled by the client	06.04.0070-00
IN10	Others, under ordering	06.04.0071-00
INCL	Cup-like insert (for use with tiny steel balls)	06.04.0162-00
IN1P	1 x 3.0mm, 1 x 6.0mm, 1 x 1/4" and 1 x 8.0mm	06.04.0159-00
IN1A	1 x 1/8", 1 x 3/16", 2 x 1/4" and 1 x 3/8"	06.04.0160-00
IN1E	1 x 4.0mm, 1 x 6.0mm, 1 x 1/4", 1 x 8.0mm and 1 x 10.0mm	06.04.0161-00

Note: When asked, the calibration certificate will be provided for the first insert ordered.

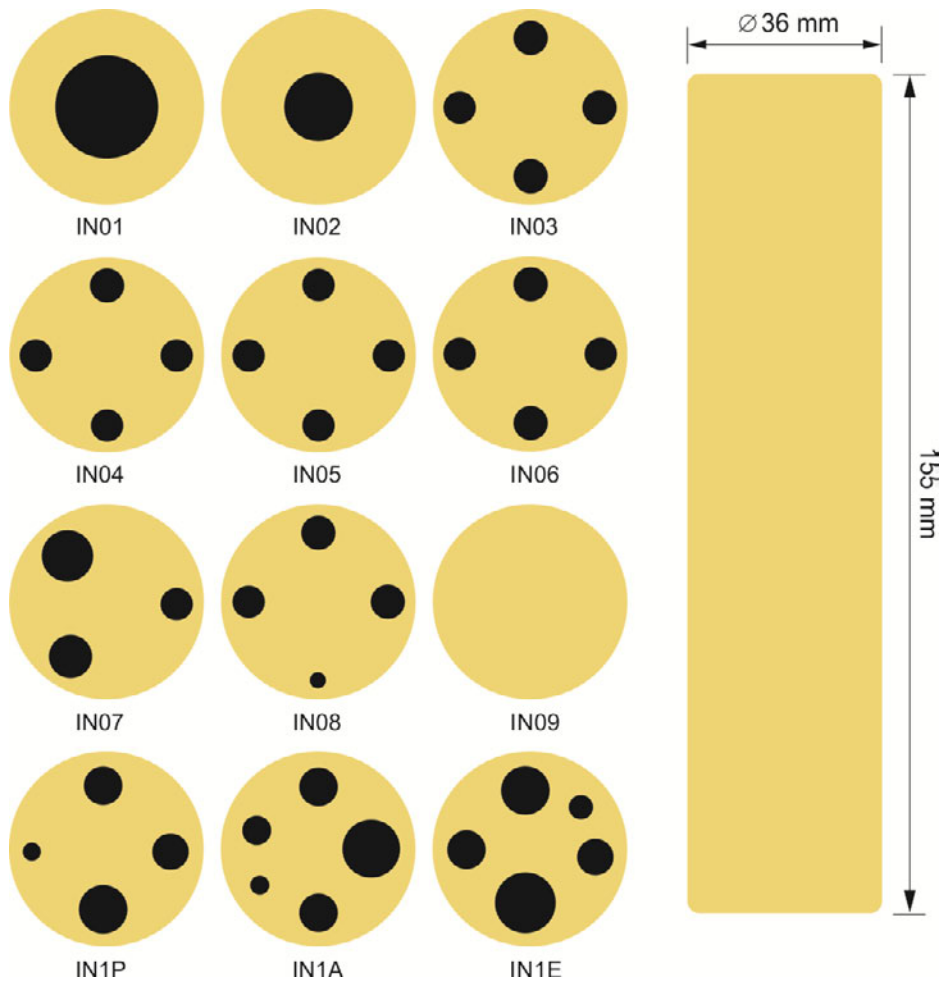

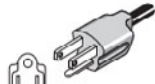
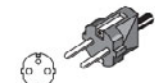



Fig. 01 - Inserts

Description		Order Code
Soft Carrying Case for TA-700PL		06.01.1032-00
Insert Extractor		02.06.0085-20
Lead Cable Kit		06.07.0018-00
Power Cable Type J – Brazil		01.14.0008-21
Power Cable Type B – US		01.14.0100-21
Power Cable Type F – Europe Universal		01.14.0089-21
Power Cable Type J – UK		01.14.0117-21

• **Accessories included:**

- 01 x Soft Carrying Case;
- 01 x Insert Extractor;
- 01 x Insert (according to order code);
- 01 x Power Cable;
- 01 x Lead Cable Kit;
- 01 x Technical Manual;
- 01 x Factory Calibration Certificate.

Notes:

- * Changes can be introduced in the instrument, altering specifications in this manual.
- * HART® is a *FieldComm Group* trademark.

1.4 - Parts Identification

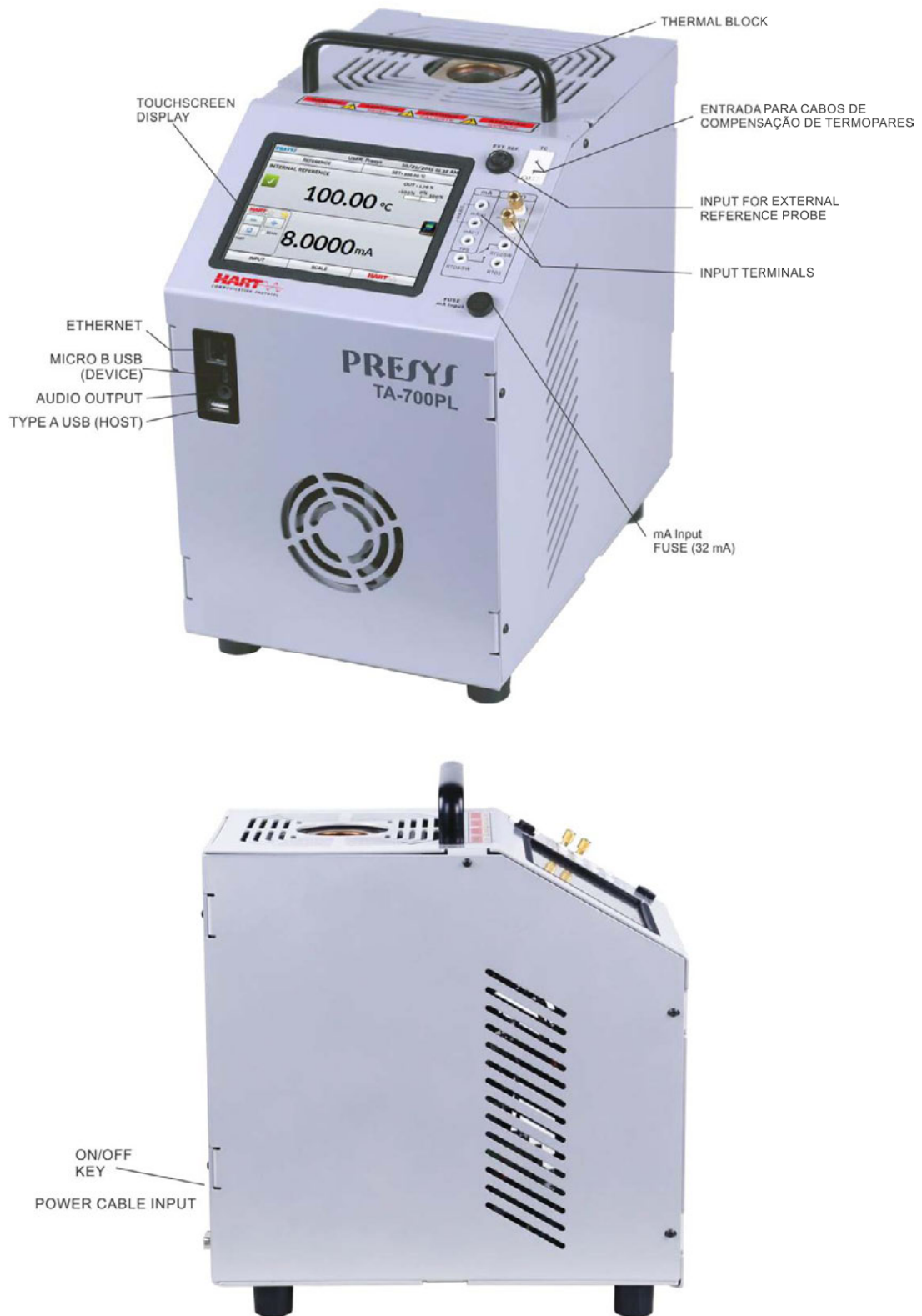

Fig. 02 - Parts Identification

1.5 - Instruction for use of the optional Black Body insert

Black Body Kit

Identify the following parts and proceed to the mounting as explained:

- Metallic Insert type Black Body cavity – Must be introduced in the pit joined with a thermocouple type N mounted laterally. There is even an extractor (similar to a screw) that can be screwed to the black body target center to help in the task of gently lower the target.

Connect the terminals of the thermocouple type N to the auxiliary input side of the furnace TA-700PL and set the reading of the input to N type thermocouple (CJC internal).

The combination constitutes an excellent mounted cavity blackbody with emissivity of $(0,95 \pm 0,02)$ and an effective target of $\varnothing 20$ mm well suited for calibration of infrared thermometers.

Align the thermometer to be calibrated with a black body cavity in the furnace in a vertical position.

Observe the distance of the infrared thermometer to be calibrated against the background of the black body cavity and the size of the actual target ($\varnothing 20$ mm) as specified in the technical manual of the thermometer.

Remember that the area targeted by the thermometer to be calibrated must be less than or equal to the effective target spot size of the blackbody in order to not introduce measurement errors.

Use the certificate of calibration of the thermocouple type N to correct the readings from the input of the calibrator and comparing the reading of the thermometer.

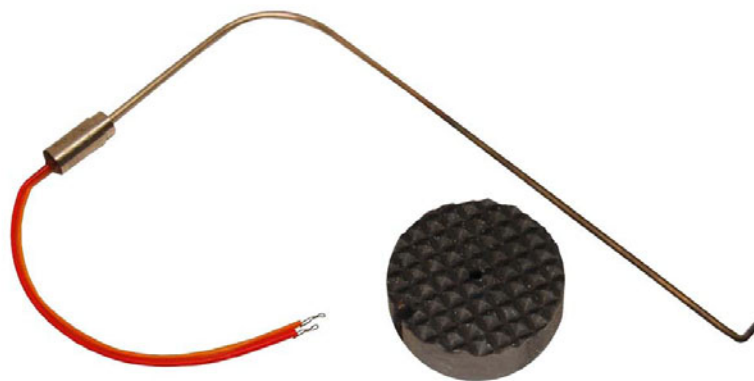

Fig 03 - Black Body Kit with N” hermocouple

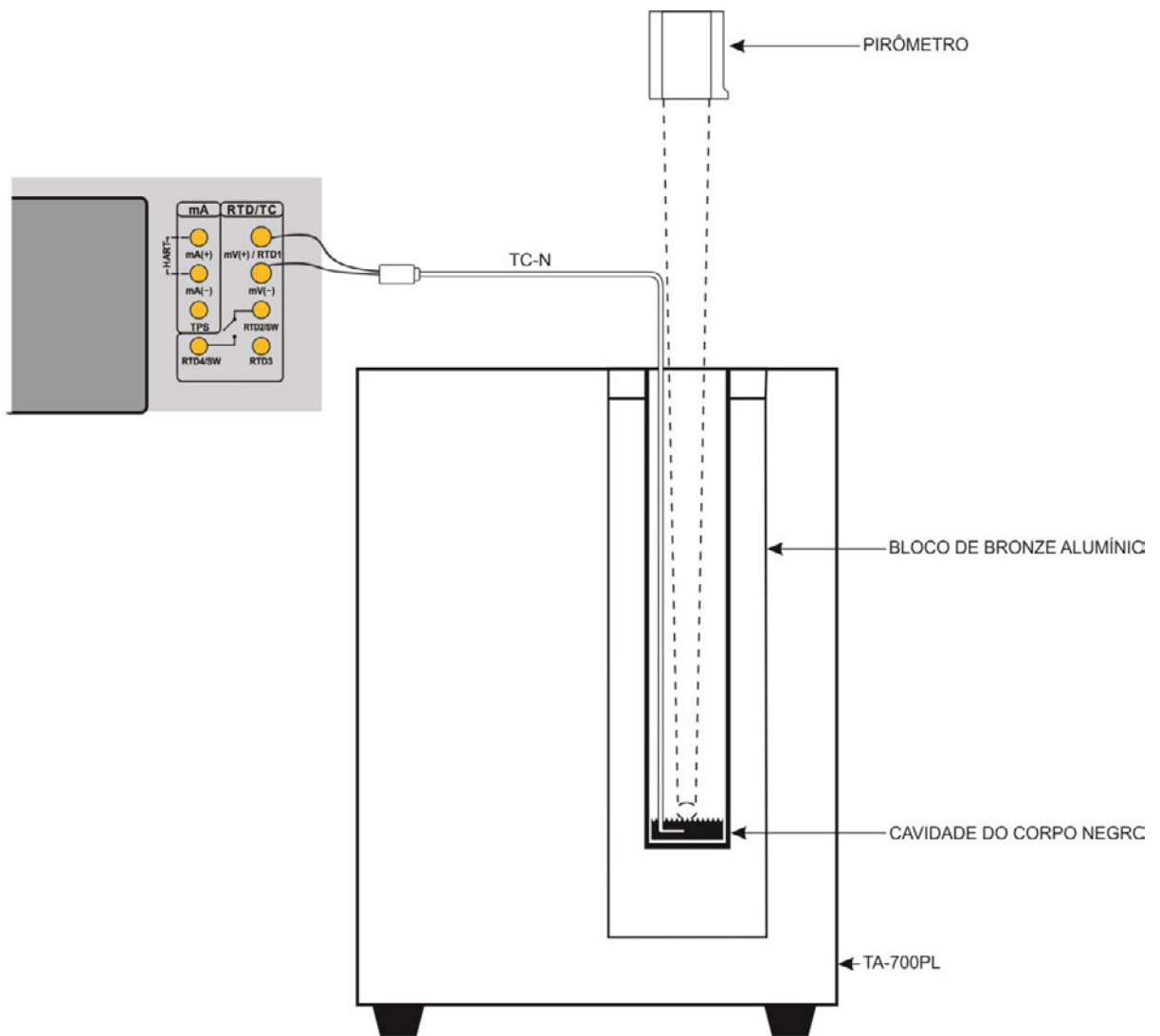

Fig 04 - Schematic view for mounting of the black body cavity

2 - Calibrator Operation

When powered on, the calibrator goes through a self-test routine and shows the last adjustment date. In case of failure, it displays a message to indicate error; if that occurs, the instrument should be sent to manufacturer for repair.

After the self-test is completed, the display shows the main menu:

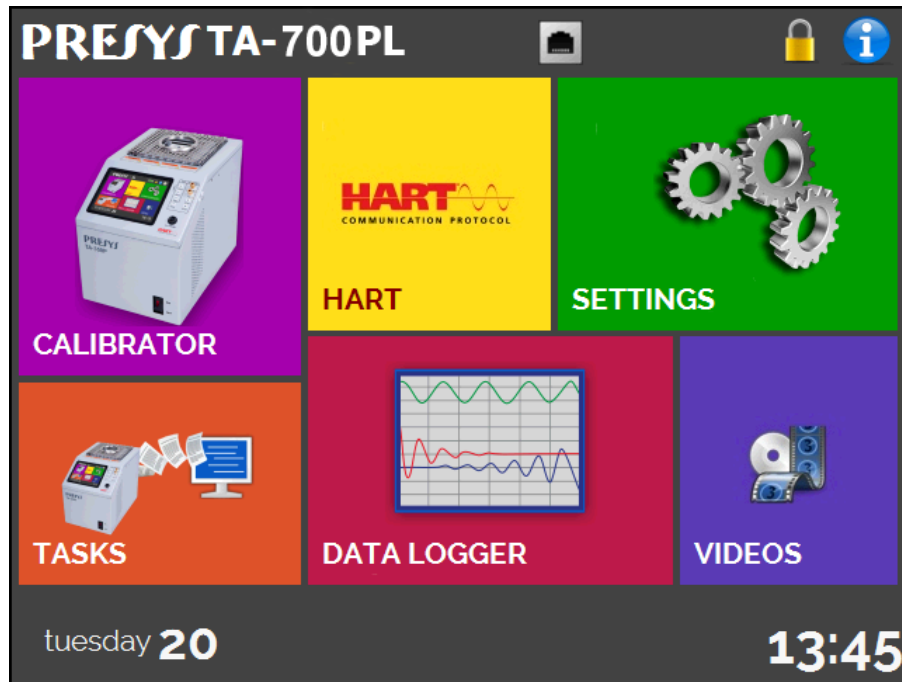

Fig. 05 - Main Menu

The main menu is divided in 06 functions:

CALIBRATOR - selects the probe and input functions, see section 2.1

HART® - optional module that allows communication with devices that have Hart® protocol, see section 2.2.

TASKS - performs calibrations automatically, see section 2.3.

DATA LOGGER - record measurements, enabling visualization in chart or table, see section 2.4.

VIDEOS - features videos made by Presys to assist in the use of the calibrator, and can also store videos made by the user, see section 2.5.

SETTINGS - general instrument settings, see section 2.6.

2.1 - Calibrator Menu

To select the probe set point or electrical input functions, from the main menu, press the **CALIBRATOR** button. The following screen is displayed.

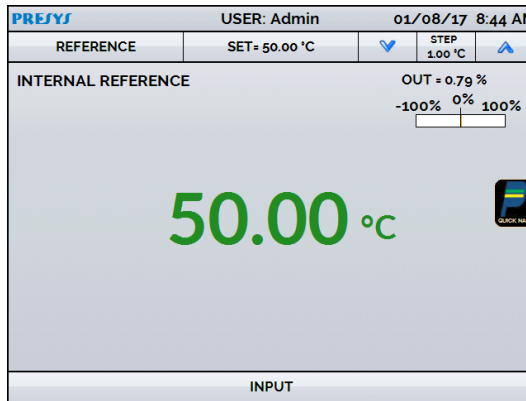

Fig. 06 - Calibrator Function

At the top is shown the probe settings and values.

The centered value shows the block temperature. The **GREEN** color indicates that the temperature is stable, otherwise it is **RED**.

The set point value appears on the top. Touch in the **SET** bar to change it.

Pressing on the temperature unit it can be changed between °C (Celsius), °F (Fahrenheit) or K (Kelvin).

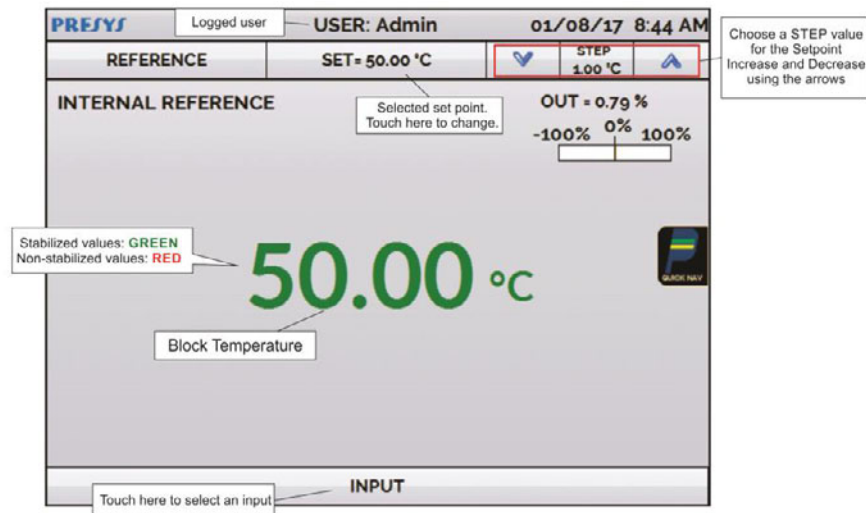



Fig. 07 - Calibrator Mode

In the **STEP** function, a step value can be configured, and the steps can be changed through the up and down arrows.

In **REFERENCE** menu, you can configure the type of probe reference (see section 2.1.1 – Probe Reference). The chosen reference appears just below the REFERENCE button.

At the bottom, an input can be configured. When the input is selected, the screen will split automatically. To select an input, just touch the INPUT bar (see section 2.1.2 MENU INPUT).

The icon  shows a **Quick Navigator**, with the options for Main Menu (**HOME**), **Data-Logger** and **Tasks**. Pressing **MENU**, there is an option for the **Memory Manager** (see section 2.1.4). Furthermore, it brings information about the probe/auxiliary input configuration and IP address. Press **BACK** to return to Calibrator Mode or **HOME** to go to Main Menu.

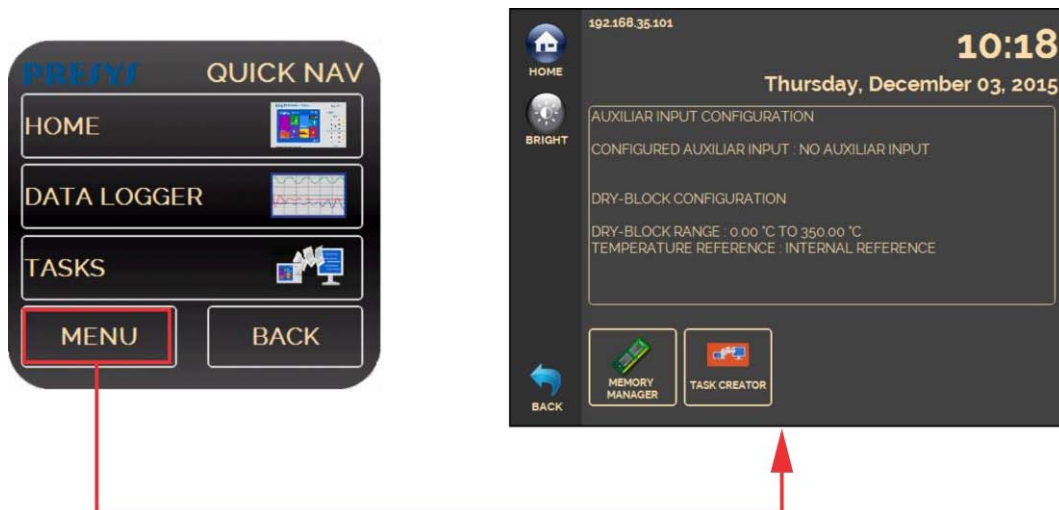

Fig. 08 - Quick Navigator and Secondary Menu

2.1.1 - Probe Settings

There are two different references to control the thermal block: **Internal Reference** and **External Reference**.

The **Internal Reference** is a sensor built into the block.

The **External Reference** is an option for more accurate measurements. The control reference comes from a Standard Sensor placed inside the insert, among the DUT (devices under test). This Standard Sensor, with Callendar-Van Dusen parameters, eliminates adjustment errors and block loading effects.

It can be used both in control and measurement mode. When used in measurement mode, the probe indication is displayed on the screen and the control is made by the internal probe.

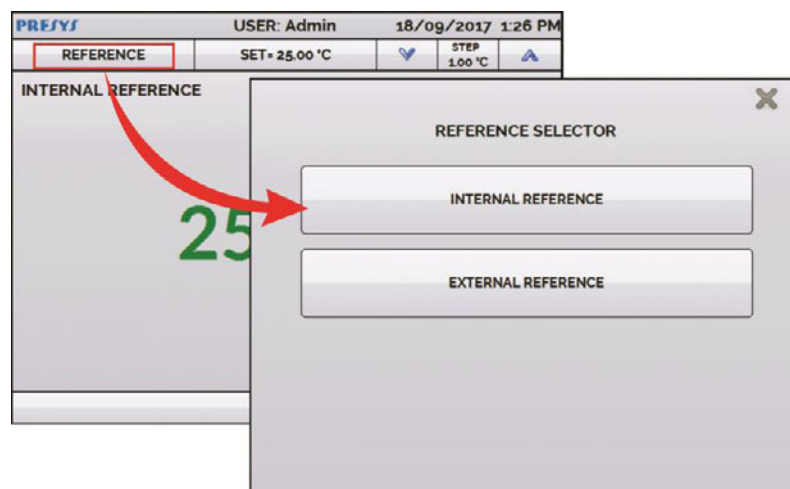

Fig. 09 - Choosing the Type of Temperature Reference

To select the Reference between Internal and External, touch the **REFERENCE** bar. When selecting External Reference, the *Callendar-Van Dusen* parameters must be set. It is also necessary to choose if the External Probe is going to control the block or not.

ID: Set an identification for the sensor

R0 (Ω): The last resistance measurement in 0 °C of the sensor

A, B, C: *Callendar-Van Dusen* coefficients

Low (°C): Lower value of the reference sensor calibrated range

High (°C): Higher value of the reference sensor calibrated range

The coefficient values can be found in the Reference Sensor Certificate.

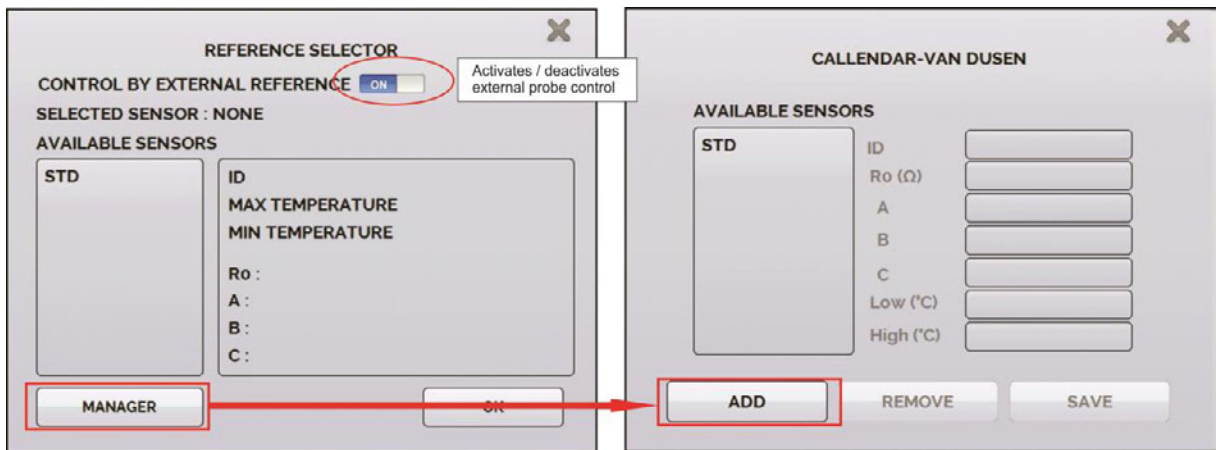

Fig. 10 - Adding a new Reference Sensor

After filling the blanks, click on **SAVE** button and confirm. The new sensor is now available to be chosen in the list. To edit data from a sensor, select it and press **MANAGER** button. To remove a sensor, select it and press **REMOVE**

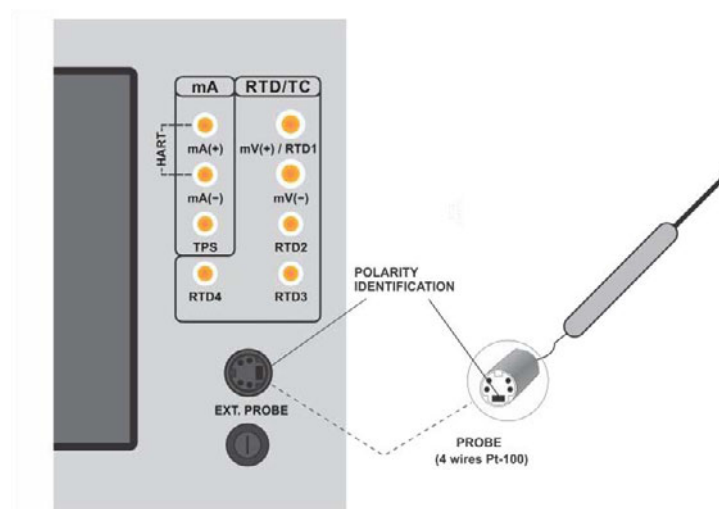

Fig. 11 - Connecting the Standard Sensor for the External Reference

Note: the values corresponding to controlled temperatures appear in **GREEN / RED**. Values that show only the sensor indication appear in **BLACK**.

2.1.2 - Input Settings

The INPUT menu has the following options:

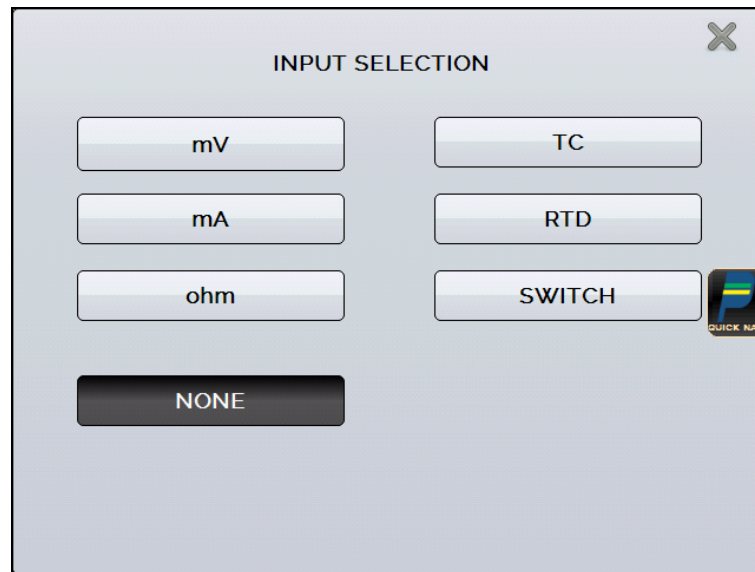

Fig. 12 - Input Menu Options

For **OHM** measurement, you should also select between 2, 3 or 4 wires options.

For **RTD** input, it should be chosen the type between Pt-100, Pt-1000, Cu10 or Ni100 (standard table used), the number of lead wires (2, 3 or 4 wires) and the temperature scale (ITS-90 or IPTS-68). There is also the option to configure the *Callendar-Van Dusen* coefficients of the sensor, selecting the option **CVD** and the desired curve in the list.

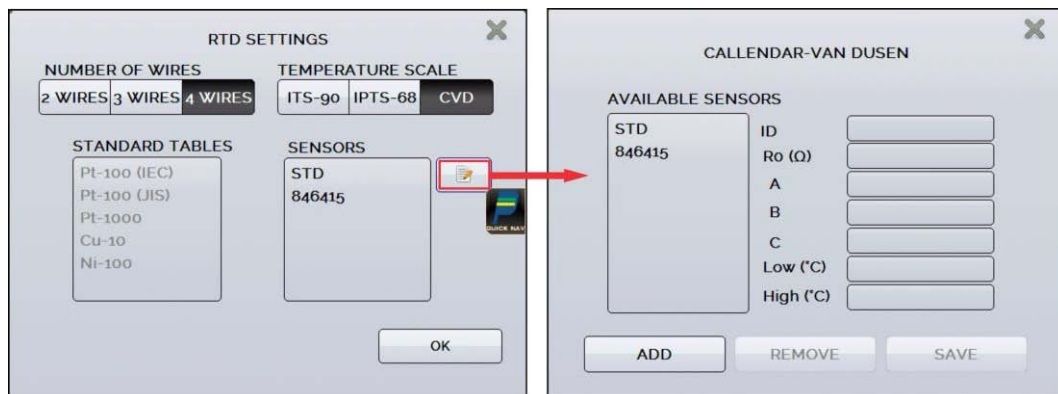

Fig. 13 - Options for RTD Input

To create new CVD coefficients, press  (**edit**), and **ADD** button. The curves appear in the created list as identified in ID.

For **TC** (thermocouple), you must select the thermocouple type and the type of cold junction compensation (CJC): **Internal** or **Manual**. In **Internal** option, the

compensation is done internally; In **Manual** you must provide the value of the temperature of the cold junction to the calibrator.

The option **SWITCH** has two ways to be used. For the option **MANUAL**, the input works as a continuity measurement between RTD2 and RTD4 terminals. When there is continuity, the input shows **CLOSED**, if not, indicates **OPEN**. The input also records the temperature value of the block at the time of contact opening / closure.

Using the option **THERMOSWITCH TEST**, the calibrator performs cycles registering the thermoswitch opening and closure interactively, in order to find the setpoint temperature of the thermoswitch and its respective hysteresis. In Setpoint Hi set a temperature above the opening of the thermoswitch contact. In Setpoint Lo, use a value below the setpoint discounted hysteresis. E.g.: To test a thermostat of 50 °C setpoint and 5 °C hysteresis, Setpoint Hi can be set to 55 °C and Setpoint LO to 45 °C.

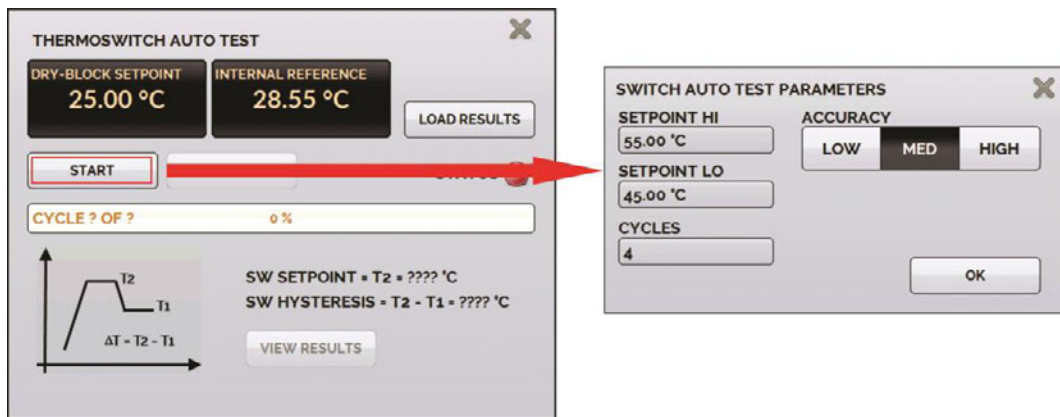

Fig. 14 - Switch Auto Test Parameters

It is important that the number of cycles be at least 3. By selecting this amount you can check the repeatability of the thermoswitch. For the accuracy, when choosing higher accuracy levels, the temperature ramp times will be higher too. If a Report is needed for this test, use the **TASK** function.

The **NONE** option turns off the input function.

When the input sensor breaking occur (RTD, resistance or probe) the display will show the burn-out warning identified by question marks illustrated below:

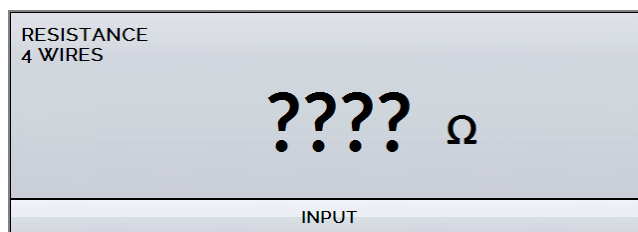

Fig. 15 - Burn-out Warning

If an out of range signal is injected, a message of **UNDER** or **OVER** range appears.

2.1.2.1 - Input Connections Diagrams

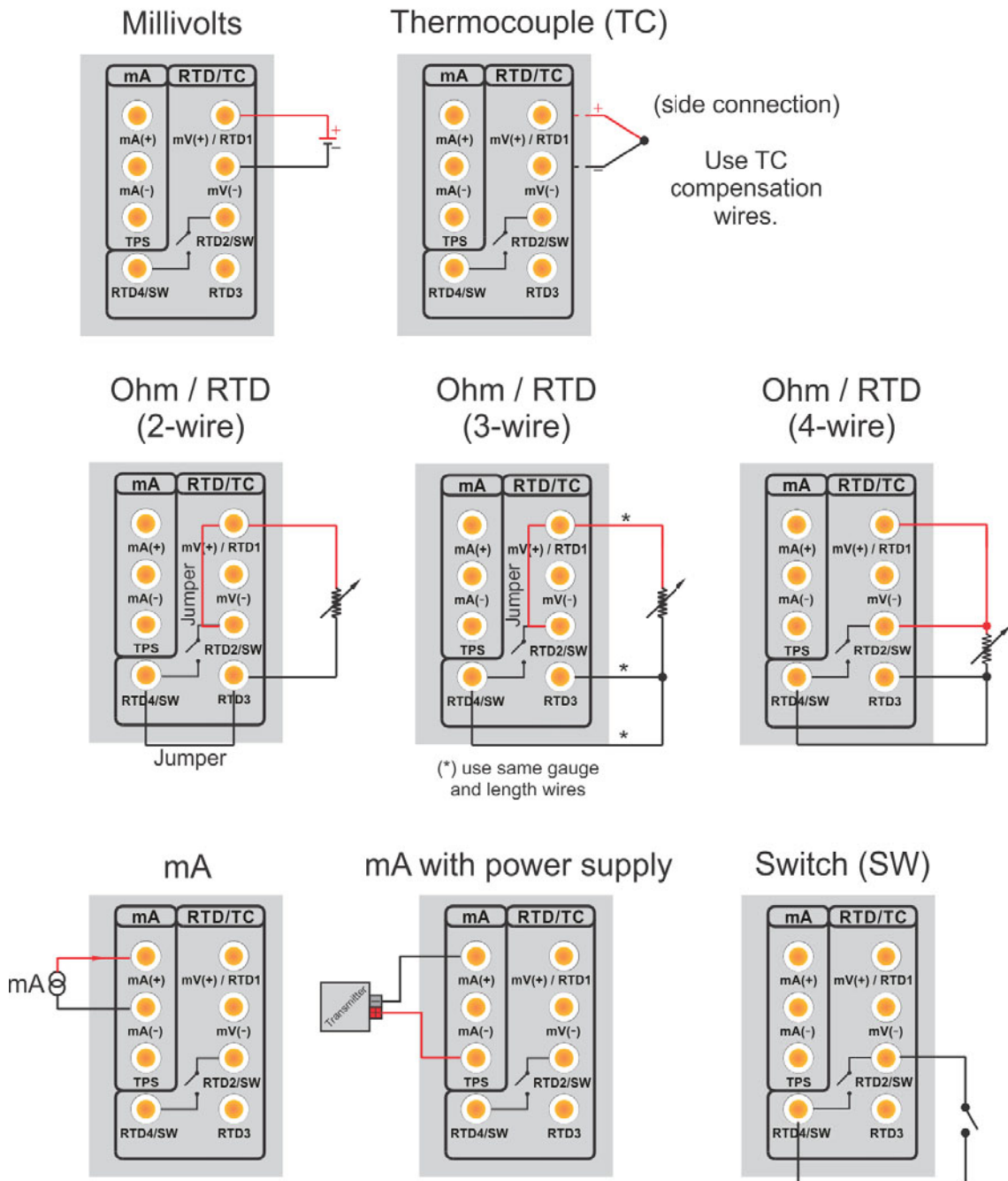

Fig. 16 - Input Connections

2.1.3 - Special Function

SCALE: For the current input, it is possible to use the scale function:

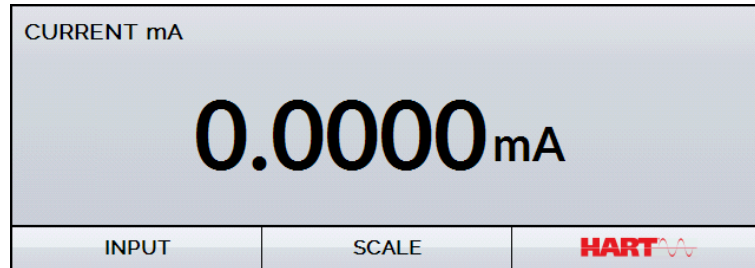

Fig. 17 - Option for mA Input: SCALE

It establishes a linear relationship between the mA input signal and what is shown at the display, according to the graphic below:

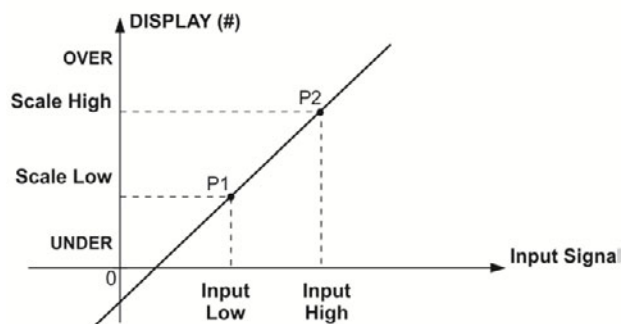

Fig. 18 - SCALE Function (LINEAR)

The scaled indication at the display (#) may represent any engineering unit, such as: °C, % etc.

The number of decimals, up to 4, shown at the display may be configured.

The value for **Input High** must be necessarily higher than **Input Low**. On the other hand, **Scale High** and **Scale Low** may have any relationship between themselves: higher than, lower than or equal to, and they may have a signal before them. Thus direct or reverse relationships may be established.

SCALE

INPUT HIGH: 20.0000 mA

SCALE HIGH: 400.0 °C

INPUT LOW: 4.0000 mA

SCALE LOW: 0.0 °C

DECIMALS: 0 1 2 3 4

UNIT: °C

TURN FUNCTION ON: OFF

OK

Fig. 19 - Scale Function Configuration

Note: To enable the Scale Function, turn the function ON before touching OK button. To disable, turn the function OFF.

2.1.4 - Saving Current Configuration (Memory Manager)

The TA Series calibrators admit several special functions that may become of frequent use. In these situations, it is useful to store such settings in the instrument in order to save time.

After setting the desired calibration mode (input type, probe reference or special function), press the icon  > **MENU**, and the button **MEMORY MANAGER**. On the option **CREATE NEW** can be given a name for this configuration and a description. Press the **SAVE** button.

The operation that was being performed by the TA Calibrator shall be stored in memory identified by the name given to it. To use it again, even after the calibrator is turned off and on, select the name of the desired setting and press the **LOAD** button. The **SAVE AS DEFAULT** button sets the current configuration as the default configuration of the calibrator. Thus, every time the calibrator is turned on, this will be the initial configuration of the calibrator.

2.2 - Hart® Configuration

The TA Series Calibrators can be used to read and set parameters in devices that have HART® Communication Protocol. The HART® Protocol allows digital communication between master (in this case, the TA Calibrator) and the slave (field instrument) superimposed on the 4-20 mA analog signal. To access this function from the main menu, select the **HART®** option.

The HART® Communication of TA Calibrators is an optional module. The calibrator has three versions: **NH** (without HART® Communication), **CH** (HART® Calibrator) and **FH** (Full-HART® configurator with DD library).

The **CH** option has basic and universal commands for HART® communication (zero, span, trim mA etc.) that allow you to adjust the range of the instrument, monitoring the primary variable, current adjustment etc. The **FH** option, in addition to basic and universal commands, is provided with the DD library (Device Description) from *FieldComm Group* and allows the setting of specific parameters of each instrument.

The following description is valid for **CH** and **FH** options.

2.2.1 - HART® Connections

To the connections shown in **Figures 20** and **21**, use the **mA INPUT + HART®** option and **INTERNAL RESISTOR** enabled. In this mode, the 250 Ω resistor is activated internally in series with the calibrator mA input. The calibrator can measure current from the transmitter and also read and set parameters via HART®. If the internal resistor is not enabled, an external resistor of at least 150 Ω must be inserted in series with the mA input. To power the transmitter, can be used **TPS** source (**Fig. 20**) or an external source (**Fig. 21**).

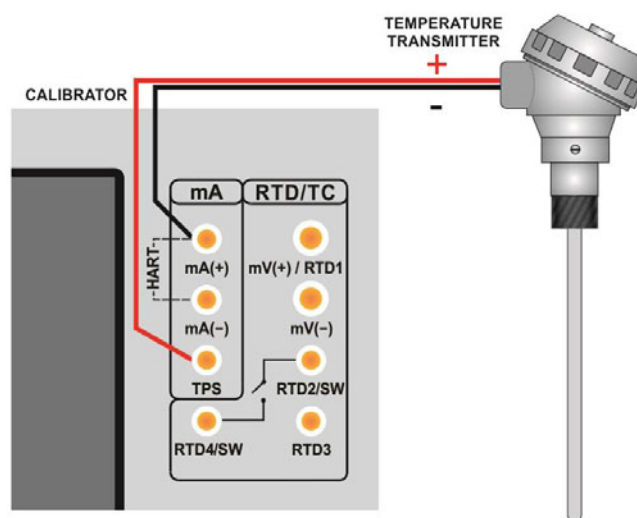

**Fig. 20 - Transmitter Powered by the Calibrator Itself (TPS)
mA INPUT + HART® (Internal Resistor Enabled)**

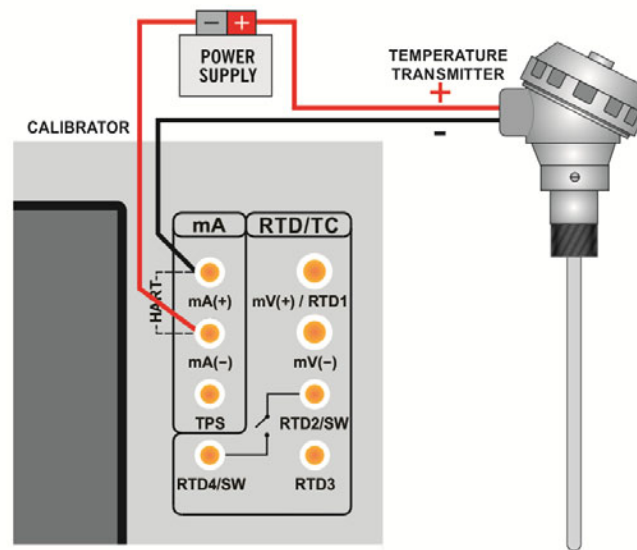

**Fig. 21 - Transmitter Powered by an External Power Supply
mA INPUT + HART® (Internal Resistor Enabled)**

2.2.2 - Starting Communication

After defining the configuration of HART® connection type, it must be inserted the **ADDRESS** of the HART® device and press the **CONNECT** button. If the instrument address is unknown, can be used the **SEARCH** button, which will search device address in the range from 0 to 15.

Are allowed up to 15 devices on a HART network (addresses 1-15). In connection with a single field instrument with poll address 0 and **mA INPUT + HART®** connection, the primary variable can be read either in analog (4-20 mA) and digital form (HART®). In connection with a single field instrument with poll address 1-15, the only way to read the primary variable is digitally.

When connecting, appears in the **DEVICE INFO** tab data identifying the instrument, such as TAG, manufacturer, description, message, date, measuring range and input filter (damping). Some of these parameters can be changed in the **DEFAULT SETTINGS**.

2.2.3 - Adjusting the Measurement Range of a HART® Transmitter

In **DEVICE INFO** tab, the **MIN** and **MAX** fields indicate the measuring range of the HART® transmitter. For PV (primary variable) equal to the MIN value, the transmitter should generate 4 mA. For PV (primary variable) equal to MAX value, the transmitter should generate 20 mA. The maximum allowable range of the transmitter is shown just above (**RANGE ...**). To edit the range of the transmitter, just change the MIN and MAX values and press the **SAVE RANGE** button.

On this screen you can also edit the unit of the primary variable and the input filter (damping).

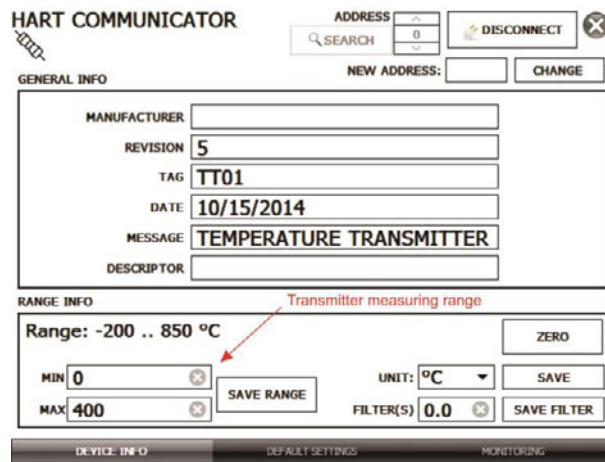

Fig. 22 - Adjusting the measuring range of the HART® transmitter

2.2.4 - Adjusting the Measurement Range of a HART® Transmitter with Reference

Another way to adjust the range of the transmitter is generating the minimum and maximum values of the desired range in the transmitter input and adjusting these values as minimum and maximum (set by reference).

To adjust the range of a temperature transmitter, insert the transmitter in the thermal block and choose the **PROBE** configuration. Select **Input mA** and press the **Hart** button. The temperature generation will work as the standard value for the adjustment range of the instrument.

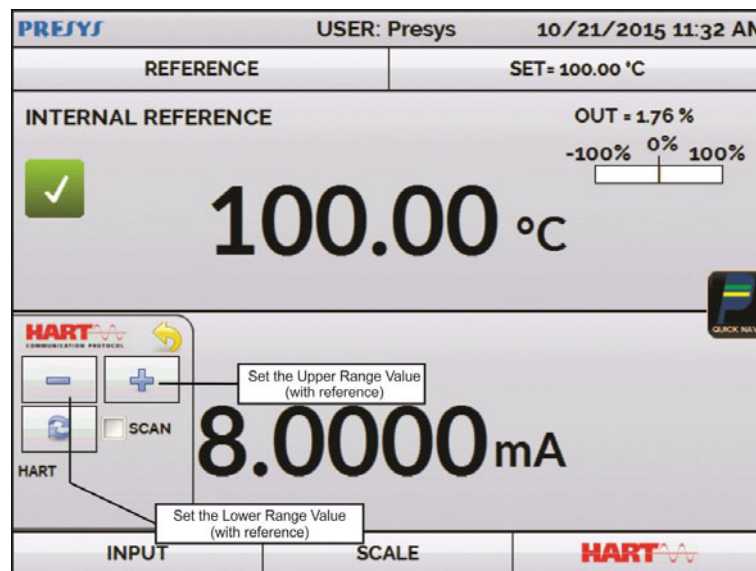

Fig 23 - Quick Hart® Adjustment with Reference

Generate the temperature to the transmitter input corresponding to the lower range value and press the **-** button. Transmitter will generate 4 mA to this value. Generate the temperature to the transmitter input corresponding to the upper range value and press **+** button. Transmitter will generate 20 mA for this value.

Another way to do this adjust is entering in the **HART** option through the **MAIN MENU**, set the connection type, address and then press **CONNECT**. Select the **MONITOR** tab. In this screen are shown the value of the primary variable (PV) read by HART® (digital), the current that the transmitter wants to generate (**AO - DIGITAL OUTPUT**), and the current measured by the TA Calibrator (**ANALOGIC READ**). Set the block temperature pressing **OUTPUT** and adjust the transmitter range pressing the ↓ **Inf Range** and ↑ **Sup. Range** buttons.

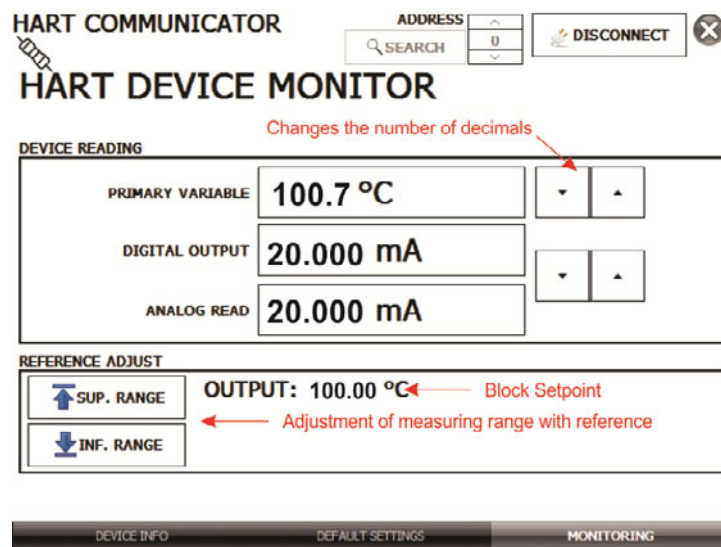

Fig. 24 - Adjusting the Measuring Range of the HART® Transmitter with Reference

2.2.5 - Checking / Adjusting HART® Transmitter mA Output

In **DEFAULT SETTINGS** tab can be adjusted the output current of the HART® transmitter (output trim) according to current measured by the TA Calibrator. You can make this adjustment only when the TA Calibrator is connected to a single transmitter with address 0, in the **mA INPUT + HART®** option of connection, since the calibrator needs to measure the current to make the adjustment.

Before performing the adjustment, a transmitter output current check can be performed by pressing the **CHECK** button. The transmitter will generate fixed current (4, 8, 12, 16, 20 mA) and the calibrator will show the measured values for each point.

To adjust automatically, simply press the **AUTO** button. The calibrator will send the command to the transmitter to generate 4 and 20 mA (fix), makes the measurement of these points, and adjusts the output (trim). The adjustment is completed when **D/A Adjustment Completed** message appears.

The **LEAD TIME** field sets the time (in seconds) of each point stabilization time.

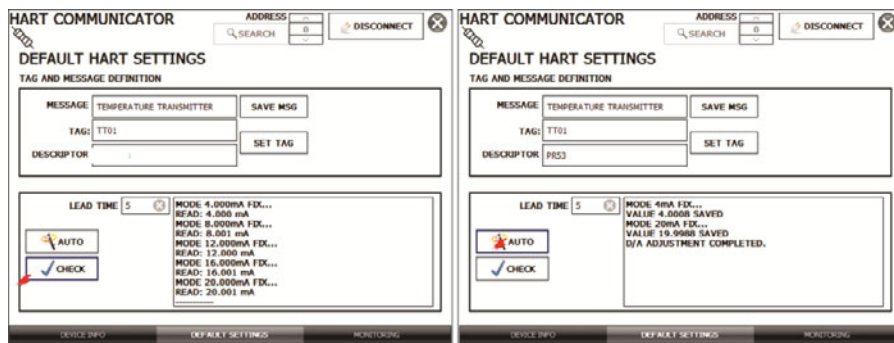

Fig. 25 - Checking / Adjusting the mA HART® Transmitter Output

2.3 - Automatic Tasks

In TA Calibrators, can be created and performed automatic calibration tasks. This option can be used to generate calibration work orders for sensors, transmitters and indicators.

2.3.1 - Creating Tasks

To create tasks from the main menu, select **CALIBRATOR**. Select the desired type of input and probe configuration. For example, to calibrate a temperature transmitter, select the probe configuration (Internal or External Reference) and mA input (which will be connected to the current output of the transmitter). For a temperature indicator, e.g., selected **NONE** for the input.



Press the **QUICK NAV** icon, and select **TASKS** and **CREATE NEW TASK**.

Fill at least the serial number of the instrument to calibrate, instrument TAG, lead time (time, in seconds, for the complete stabilization of the system), maximum error allowed for the instrument to be calibrated (in % of the span, reading or full scale), calibration range (highlighted fields). For the SWITCH tasks, the error fields are filled in the next step.

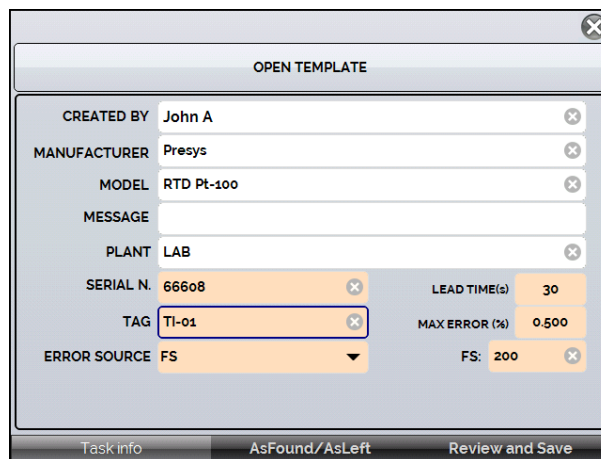

Fig. 26 - Task Information

Go to the **As Found/ As Left** tab. Add each point to be generated by the TA Calibrator and the expected value for the UUT (unit under test) both **As found** (calibration done before adjustment) and **As left** (calibration done after adjustment) values. Points can also be generated with the help of **AUTO** button. By pressing this button, simply enter the maximum and minimum values of the calibration and the number of points that need to be generated considering the same steps and linear scale. Also fill the number of repetitions (**REP**) of the readings, and the calibration strategy (initial to the final point ↑, final to the initial point ↓, etc.). If 0 value is set in as found repetition, the task will execute only AsLeft calibration.

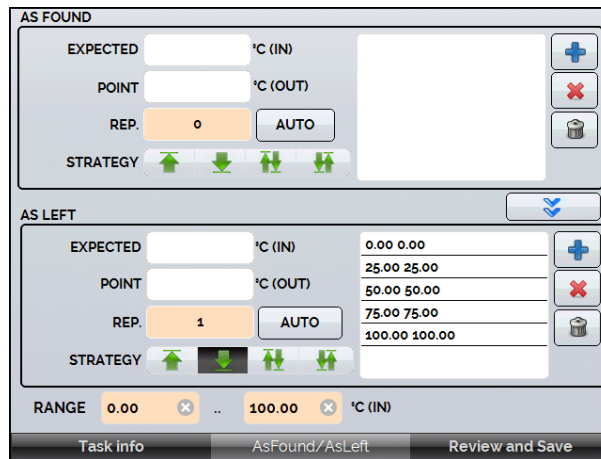

Fig 27 - Task Points and Strategy

For **SWITCH** tasks, the screen is different, as shown in the figure below. It must be filled the TRIP POINT of the thermostwitch and its DEADBAND, as well as their respective error. The TIME RAMP is the time in seconds that the calibrator will take to tour the range and find the value of opening and closing the thermostwitch. The minimum value for this field is 300 s.

Tip: If the Trip point and deadband are not known, try the THERMOSWITCH TEST to find an approximate value before creating the task.

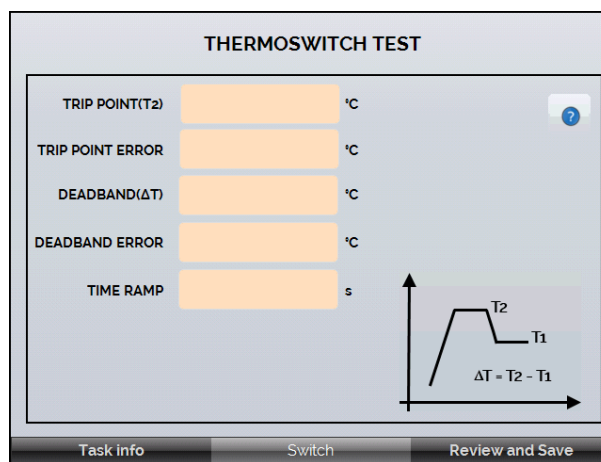

Fig 28 – SWITCH Task Parameters

Go to the **Review and Save** tab and choose an identification name/number for your task. If you want to save the model of this task for later use to create other tasks, press **SAVE TEMPLATE** and give a name for it. When you want to open this model again, open the task creation screen and press **OPEN TEMPLATE** in **Task info** tab. Click on **CREATE** button to create it. The task is now saved in the calibrator.

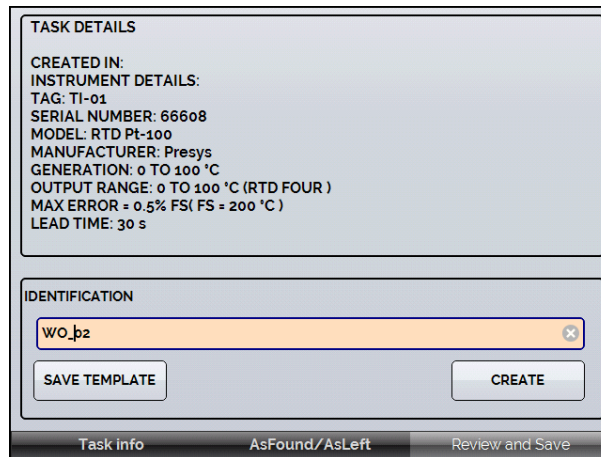

Fig 29 - Creating a Task

2.3.2 - Performing Tasks

To perform a task created from the main menu select **TASKS > EXPLORE TASKS**. A list identifying the created work orders that have not been performed yet (● **WAITING**) is shown. Select the desired task and press **OK**. Make the necessary connections between the calibrator and the instrument to be calibrated and press **START**.

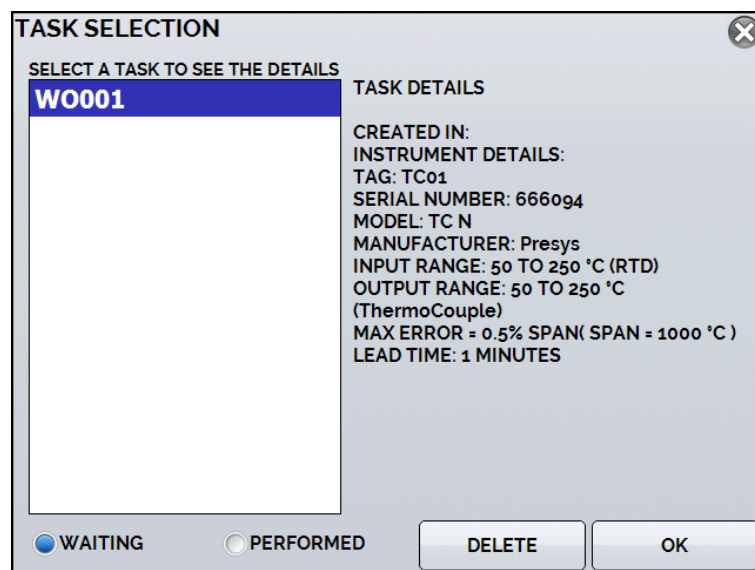

Fig 30 - Exploring Tasks

The TA Calibrator automatically starts to do the calibration generating setpoints registered on task and doing the reading of the instrument to be calibrated. If you select the option **NONE** as input, for each generated point the calibrator requires the value read by the instrument. The result will be displayed on the screen, and a progress bar is displayed to indicate the calibration remaining time. At the end of the calibration, a report is shown with the generated values, the obtained values, the expected values, and the error. If the error is higher than the registered value for the task, the line appears in red.

The first time that a task is performed, it will be saved as **Asfound** (before adjustment). If it runs again, it will be saved as **Asleft** (after adjustment). The results are saved in the calibrator and can be viewed at any time.

2.3.3 - Viewing Results

Once a task has been performed, it remains saved in the calibrator.

To view the results of a calibration by the calibrator, in the main menu select **TASKS**.

Enable the option **PERFORMED**. The list will show only the tasks that have been performed. Select the desired work order and press **OK**. On screen, the report with the calibration points, the obtained values, expected values and the errors will be shown. If the error is higher than the value registered for the task, the line appears in red.

AS FOUND				
POINT	EXPECTED	OBTAINED	ABS. ERR.	SPAN ERR.
AS LEFT PERFORMED BY: John A.				
POINT	EXPECTED	OBTAINED	ABS. ERR.	SPAN ERR.
49.99 °C	50.0 °C	49.0 °C	-1.0 °C	-0.099%
100.01 °C	100.0 °C	99.0 °C	-1.0 °C	-0.101%
150.04 °C	150.0 °C	148.9 °C	-1.1 °C	-0.114%
200.01 °C	200.0 °C	198.7 °C	-1.3 °C	-0.131%
250.02 °C	250.0 °C	248.5 °C	-1.5 °C	-0.152%

Fig. 31 - Task Results

The task data is saved in a PDF file in the internal memory card of the Calibrator and can be accessed connecting the calibrator to a computer. To save the data in a PenDrive or External HD on the host USB, press the Pen-Drive icon  .

To print the Calibration Report, press the printer icon  . The printer must have been previously configured in **SETTINGS > SYSTEM > PRINTER CONFIG**.

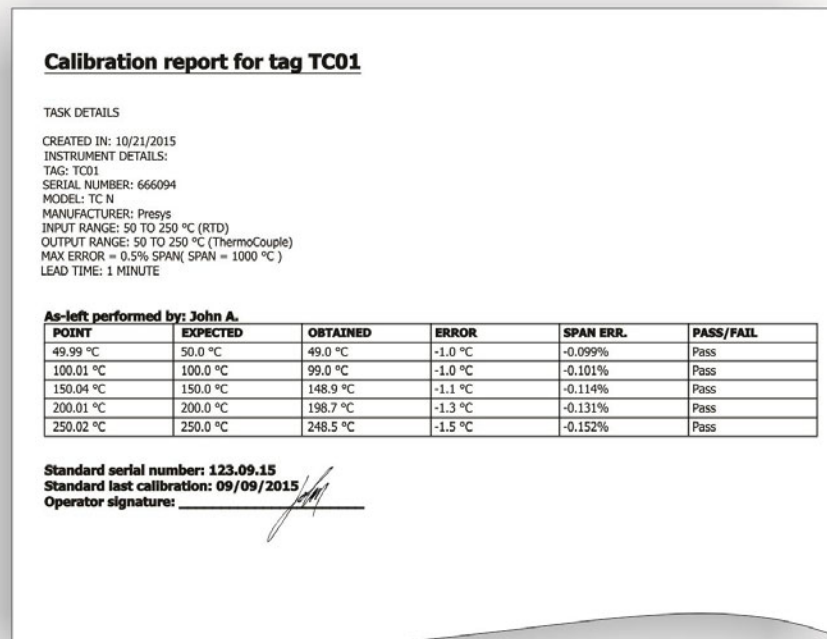

Fig. 32 - Example of a Printed Calibration Report

2.4 - Data-Logger

The TA Series Calibrators allow you to record series of measurements over time to display data in chart or table format.

Select **CALIBRATOR** from the main menu and select the desired configuration for Probe and Input.



Press the icon and select **DATA LOGGER**.

The calibrator automatically starts the measurements and displays each measured point on the chart.

For measurements to be saved, you must press the **REC** button (see **Figure 33**). With this option selected, all points (measurement and time) are saved in an internal file in TA Calibrator, which can be used to generate a table or chart.

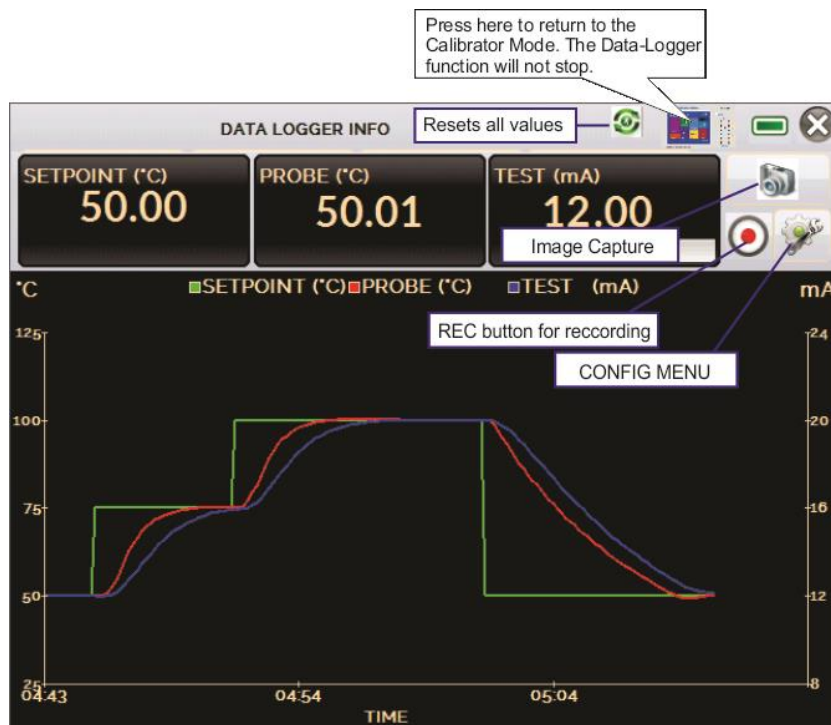



Fig. 33 - Data Logger

In configuration menu (icon ) , you can edit the background color of the chart, color and line thickness, sampling rate (in seconds) and set the x (time) and y (measurements) axis of the chart.

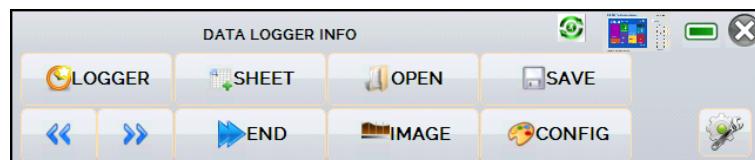



Fig. 34 - Data-Logger Configuration Menu

Recording can also be programmed to start at a certain date and time in the **LOGGER** option. Just set the start time and end time of recording. During the defined range, the measured points are saved in an internal file in TA Calibrator.



To view a saved file press the **OPEN** button, select the desired file, and press **LOAD**. The file name contains the date and time of the measurements.

The **SHEET** button allows the visualization of data in table format, with the date and time of the measurement and the measured values.

If the user wants to export the current data to a .csv file that can be opened in spreadsheet softwares, press the **SAVE** button and indicate the name and where it will be saved. The button  saves the current screen image as a .png file. All saved screens can be viewed in the **IMAGE** menu. These files are saved in the internal SD card of the calibrator. To access the files saved on the TA Calibrator, connect the USB cable to the computer (type A USB) and to the TA Calibrator (Micro-B USB, see **Figure 2**).

2.5 - Videos

TA Series calibrators have a video player. These videos can be viewed while a calibration is performed and are designed to assist in the use of the calibrator.

From the main menu, selecting **VIDEOS** a list of video categories appears. Select the category and the desired video. Press the FULL SCREEN button  to view the video in full screen and the WINDOW button  to reduced screen.

To add new videos on the calibrator, connect the USB cable to the computer (type A USB) and to the TA Calibrator (Micro-B USB, see **Figure 2**). Open **VIDEOS** folder. Copy the new video to any sub-folder (category) of the VIDEOS folder. If you prefer to create a new category, simply create a new folder inside VIDEOS with the name of the desired category and copy the video to this folder.

2.6 - Settings

2.6.1 - System

In the **SYSTEM** tab, you can set the volume of the calibrator, the touchscreen calibration, identification of the calibrator, language, printer and security options.

- **Touchscreen Options**

To adjust the touchscreen, press the TOUCHSCREEN OPTIONS button. Press on the screen the places indicated by + (it is recommended to use the stylus for touchscreen). After the calibration, press again on the screen at any point. Confirm the calibration to return to SYSTEM Menu.

- **Brightness**

Select the display brightness. The options are 25%, 50%, 75% and 100%.

- **Language Setting**

Press the desired language for the system and confirm in OK button. The system must be restarted to apply the configuration.

- **Calibrator Identification**

In this option is possible to identify your calibrator, choosing a TAG name, Owner name and Location.

- **Sound Options**



Press + or - to configure a value for the system audio volume.

- **Printer Config.**

Select the Configuration for the Printer and connect it to the USB port.

- **Security Options**

The instrument initially has no access password. This setting can be changed in **SECURITY OPTIONS**.

To create a new user, press the key icon  and then users icon . Fill the blanks and press **CREATE**. It is possible to add a signature that will be used on the calibration report.

Pay attention to the functions that each user level has access in the table below:

User Level	Function				
	Calibrator	Tasks	HART [®]	Data-Logger	Settings
Operator	✓	✓	✗	✗	✗
Tec	✓	✓	✓	✓	✗
Admin	✓	✓	✓	✓	✓

To lock the system, press the padlock icon  on system menu. The next time the TA Calibrator is turned on, it will request login and password. To unlock the system, login as an Admin Level user and press the padlock icon on system menu again.

- **Adjust Cal.**

Adjustment level protected by password. See section 5.0 Calibration (Adjustment) for more information.

2.6.2 - Network

In **NETWORK** tab you can configure the IP address for the Ethernet communication with the computer. The IP address can be dynamically configured (**DHCP**) or may have a fixed address (disable **DHCP** option and edit the desired address).

By connecting the calibrator to the network you can view and print reports of the tasks on the computer.

2.6.3 - Built-in Web Server

Connect the network cable into the Ethernet port of **TA Calibrator** on the side (see **Fig. 2**).

To access the built-in webserver open the web browser on your computer and enter the following address.

```
<calibrator_IP_address>:5000/taserver/pages/main.cgi
User: admin
Password: xvmaster
```

To verify the IP address press the button indicated below.

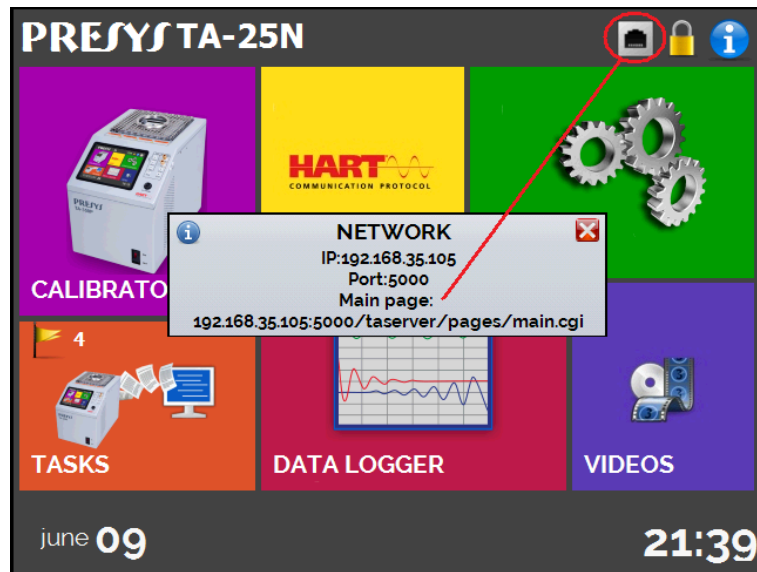

Fig. 35 - IP address

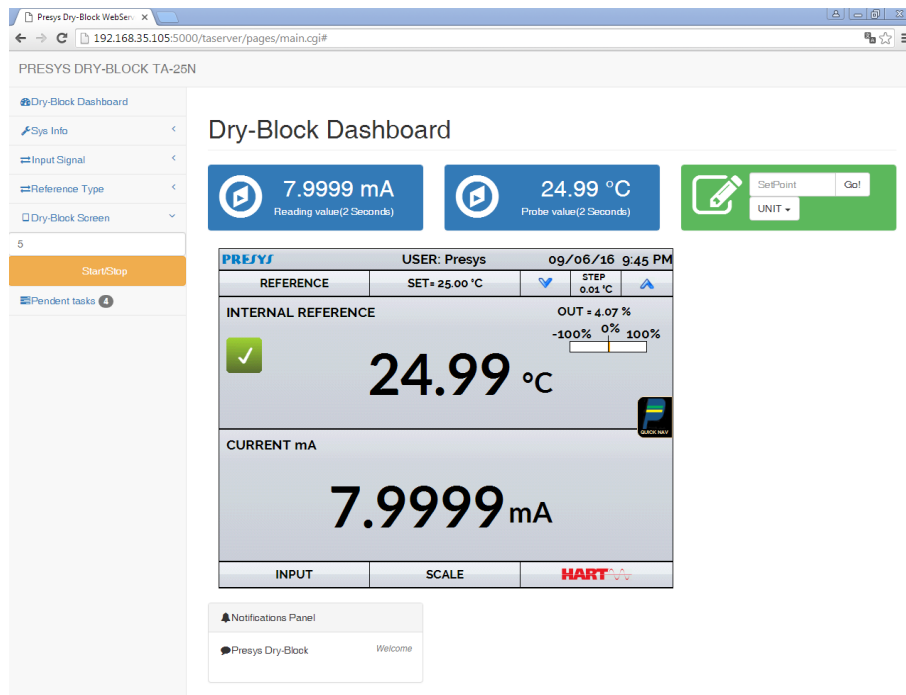

Fig. 36 - TA Calibrator Web Server

In the Web Server, you can monitor the calibrator screen, change the setpoint and see the auxiliary input readings.

3 - Safety Instructions



- If the calibrator is turned on, do not leave the room without an identification or warning about the high temperature hazard.
- Before turning the calibrator off, return the block temperature to values close to the ambient temperature.
- Never remove the insert from the dry block or the thermo-elements from the insert, while they are in temperatures far from the ambient. Wait until they reach the ambient temperature so that the heterogeneous cooling of the parts do not jam each other.

4 - Recommendations as regards Accuracy of Measurements



PRESYS Temperature Advanced Calibrators are instruments of high accuracy level, requiring the observation of all the procedures described in this section, in order to achieve the necessary conditions to get the accuracy levels during the calibrations.

- Special attention should be paid in relation to the insert cleanliness. When necessary, it should always be washed with water and soap, well rinsed and dried. Oil, grease, solid particles can hinder the heat transference to the insert and even jam the insert inside the block.
- The sensor to be calibrated must fit snugly into the appropriate well. In case the sensor is loose, the measurement accuracy meaning can be completely senseless. The meaning of clearance between the sensor and the respective well should be understood in a subjective way and the common sense is very important. Thus, the sensor should enter the insert well (both completely clean) in such a way to stay snugly enough so that it cannot move or swing inside but it should not enter by force to get jammed.

5 - Calibration (Adjustment)



Warning: Enter the following options only after understanding them completely. Otherwise, it may be necessary to return the instrument to the factory for recalibration!

Select **ADJUST/CAL** option from the **SETTINGS > SYSTEM** menu. You should then enter the password **9875** to access the calibration menu.

The password functions as a protection to calibration ranges. After the password is entered, the menu displays the options **GENERAL, INPUTS** and **PROBE**.

Options for **INPUTS** are **mV, mA, ohm** and **thermocouple**.

5.1 - Input Calibration

Select the corresponding mnemonic and apply the signals presented in the tables below.

Note that the applied signals just need to be close to the values shown in the table.

Once the signal has been applied, store the values of the calibration points 1 and 2. Press **SAVE** to save the typed values

mV Input	Point 1	Point 2
G4	0.000 mV	70.000 mV
G3	0.000 mV	120.000 mV
G2	0.000 mV	600.000 mV
G1	600.000 mV	2400.000 mV

mA Input	Point 1	Point 2
Single range	0.0000 mA	20.0000 mA

Input calibration for Ω is performed in two steps:

a) Application of mV signal:

For the calibration below, leave terminals RTD3 (+) and RTD4 (+) short-circuited.

mV Signal	Terminals	Point 1	Point 2
V_OHM3	RTD3(+) and mV(-)	90.000 mV	120.000 mV
V_OHM4	RTD4(+) and mV(-)	90.000 mV	120.000 mV

b) Application of standard resistors:

Connect a decade box or standard resistors on terminals RTD1, RTD2, RTD3 and RTD4 (4-wire connection).

resistors	Point 1	Point 2
OHM3	20.000 Ω	50.000 Ω
OHM2	100.000 Ω	500.000 Ω
OHM1	500.000 Ω	2200.000 Ω

The cold junction calibration (Thermocouple) is performed measuring the mV(-) terminal temperature. Store only the point 1.

Cold Junction	Point 1
CJC	32.03 $^{\circ}\text{C}$ (measured value)

5.2 - Probe Calibration

To readjust the internal Probe it is necessary to compare the value indicated by the calibrator (Probe) and the temperature value from a standard probe placed in the dry block insert. The temperature of the standard probe should have high accuracy.

The option to adjust the internal sensor has seven points of adjustment. These points are recorded via points 1 to 7.

Before starting the calibration (adjustment), record in these points the respective initial storing values, according to the table below:

Calibration Point	Initial value to record (°C)	Standard indication	New value to record	New indication of the Standard
Point 1: 50 °C	50.00	49.971	49.97	49.995
Point 2: 150 °C	150.00	149.964	149.96	149.995
Point 3: 250 °C	250.00	249.943	249.94	249.990
Point 4: 350 °C	350.00	349.906	349.91	350.009
Point 5: 450 °C	450.00	449.847	449.85	450.000
Point 6: 550 °C	550.00	549.815	549.82	549.995
Point 7: 650 °C	650.00	649.782	649.78	650.005

Select the calibration point and then press **CHANGE TEMPERATURE**. Wait for the complete stabilization of the point. On the field **Adjusted Point**, write the value presented in the standard thermometer and confirm in **SAVE** button. Go to the next point and continue the adjustment until the last point.

5.3 - PID Control Parameters



The TA temperature calibrators have a PID control algorithm to calculate the block control output.

The dry block stability and response time features are related to the PID parameters, explained below:

The K parameter (proportional gain) amplifies the error signal between the setpoint and the block temperature to establish the output signal. When this parameter is very high, the output reaction is very quick, however this can take the system into oscillation. Decreasing this parameter, the dry block would not be able to react quickly enough to external variations, giving the impression of a sudden out of control.

The I parameter (integral gain) is responsible for the integral action and it is the most important part in the setpoint control. While an error persists between the setpoint and the block temperature, the integral action will actuate on the output signal until the error is brought to zero.

The D parameter (derivative gain) is responsible for the derivative action that provides a quick response at the control output resulting from any rapt variation in the block temperature. It is used to eliminate oscillations. However, it can cause oscillations in the presence of much noise.

All temperature calibrators are tuned in factory and the parameters are close to the optimum ones. In case one wants to improve a specific feature of the calibrator (stabilization time or response time, for instance), make sure the alteration is made reasonably.

The changes can be made entering the menu **SYSTEM > GENERAL> PID CONFIG**. This menu is protected by password (**9875**).

6 - Maintenance

6.1 - Instructions for Hardware Maintenance



There are no parts or components inside the temperature calibrator that can be repaired by the user. Only the 6 Amp fuse, placed within the socket on the rear can be replaced in case of blow.

The fuse may blow due to a voltage spike in the mains or a calibrator component fault. Replace the fuse once. If a second fuse blows again, it is because the fault is not that simple. In this case, contact the Presys technical support.

In case of malfunction of mA input, the input fuse (250 V/32 mA) can be exchanged.

6.2 - Instructions for Insert Jamming



If, by chance, it happens that an insert jams inside the block proceed as follows.

- 1- apply a lubricant oil between the parts;
- 2- apply cooling liquid inside the insert wells in order to contract the insert;
- 3- try again to withdraw the insert.

After taking the insert out, sand both the surfaces with thin sandpaper, polish them with an suitable paste and finally clean the parts using alcohol or solvent.



PRESYS